

Quick Installation Guide

Printer Overview

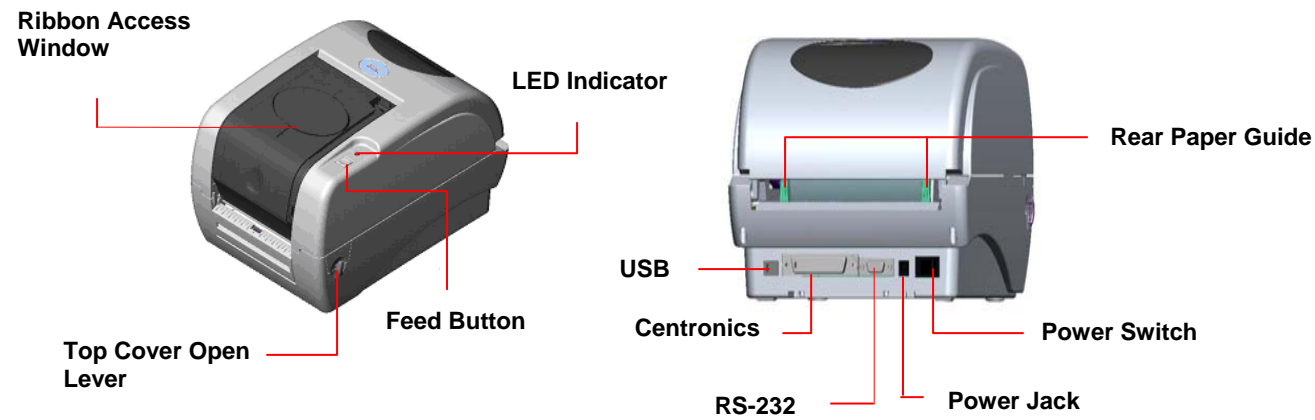

Printer Installation

1. Place this printer on a flat stable surface and make sure the power switch is turned off.
2. Connect the printer to the host computer with a Parallel Centronics, Serial RS-232C or USB cable.
3. Plug the power cord into the power jack connector at the rear of the printer, then plug the power cord into a properly grounded outlet.



Loading the Ribbon

1. Push down the ribbon access window to open the cover.



2. Place a paper core on a ribbon rewind spindle.

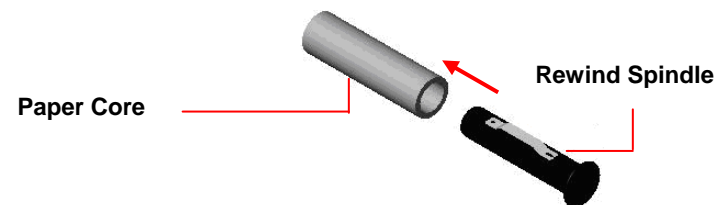

3. Mount the ribbon rewind paper core on the front hubs.

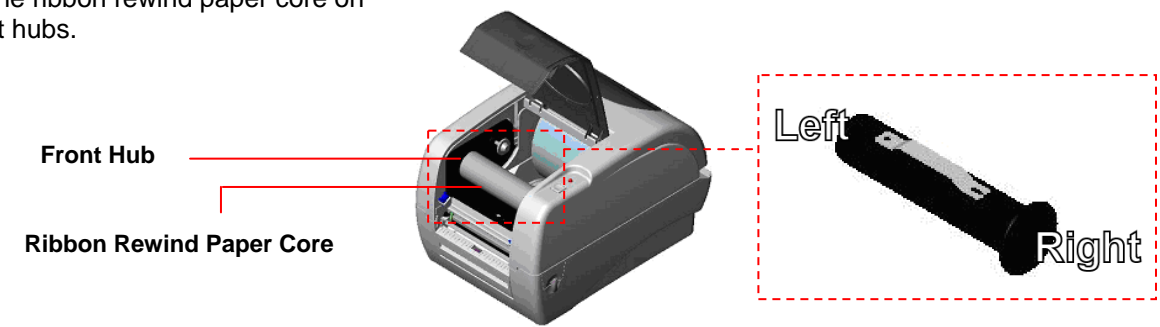

4. Install a ribbon on the ribbon supply spindle.

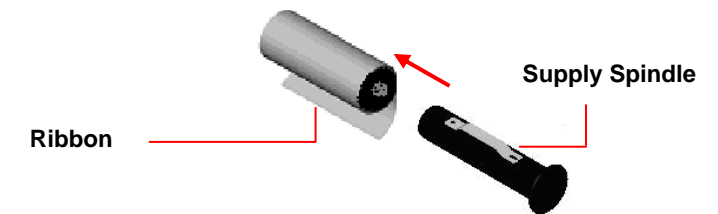

5. Mount the ribbon supply spindle on the rear hubs.

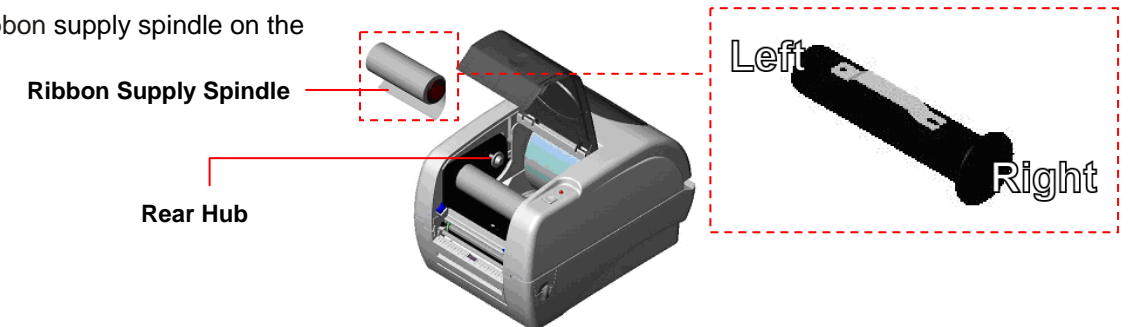

6. Open the printer's top cover by releasing the green top cover open levers located on each side of the printer and lifting the top cover. Pull the ribbon from the ribbon supply spindle and cross the print head, stick the ribbon onto the ribbon rewind paper core.

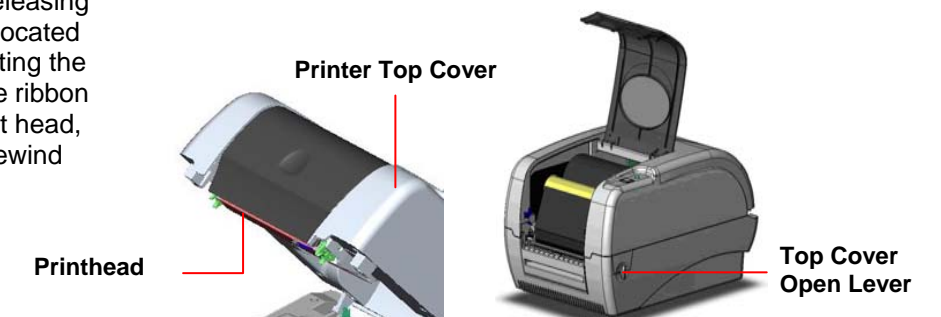

7. Rotate the ribbon rewind paper core until the ribbon leader is thoroughly, firmly encompassed by the black section of the ribbon.
8. Close the ribbon access window and lift up the top cover to the ultimate angle then close the top cover gently and it will be kept at a stop position between 1 and 2 for a while. Use both hands to gently push down the top cover to close it and make sure the cover is latched on both sides.

Note: The printer automatically detects if a ribbon is installed after power on and will switch to thermal transfer or direct thermal printing mode. If the printer does not detect a ribbon (direct thermal mode), the motor that drives the ribbon spindles will be turned off. Make sure both the ribbon access window and the printer top cover are closed when powering the printer up.

Loading the Label

1. Insert a 1" label spindle into a paper roll (* If your paper core is 1 inch, remove the 1.5" core adapter from the fixed tab).

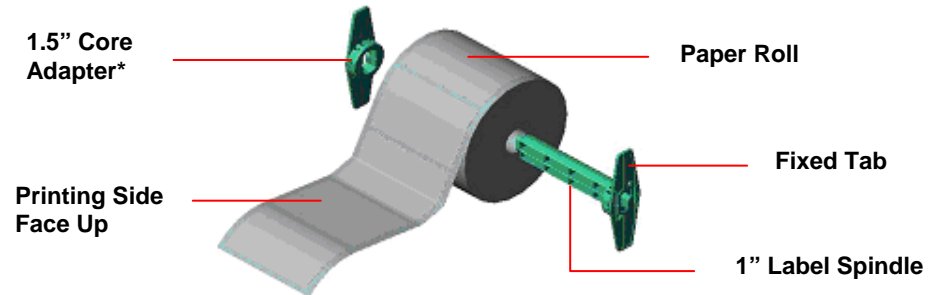

2. Open the printer's top cover by releasing the green top cover open levers located on each side of the printer and lifting the top cover. A top cover support at the rear of the printer will hold the printer top cover open.



3. Place a roll of paper onto the center of the paper roll mount.
4. Feed the paper, printing side face up, through the teflon bar, paper guide and pass over the platen.
5. Adjust the green center-biased paper guides in or out so they are slightly touch the edges of the label backing.
6. Lift up the top cover to the ultimate angle then close the top cover gently and it will be kept at a stop position between 1 and 2 for a while. Use both hands to gently push down the top cover to close it and make sure the cover is latched on both sides.
7. Use the "Diagnostic tool" to set the media sensor type and calibrate the selected sensor. (See "Diagnostic tool" in the box on the right side of this page)

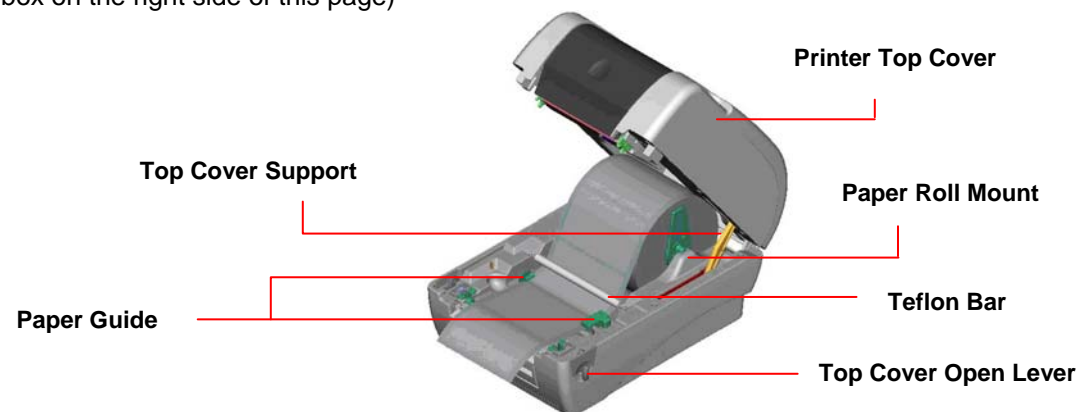

Note:

1. Please calibrate the gap/black mark sensor when changing media.
2. Failure to securely close and lock the cover will result in poor print quality.

Button Functions

(1) Feed labels

When the printer is ready, press the button to feed one label to the beginning of next label.

(2) Pause the printing job

When the printer is printing, press the button to pause a print job. When the printer is paused the LED will blink green. Press the button again to continue the printing job.

Diagnostic Tool

The Diagnostic Utility is a toolbox that allows users to explore the printer's settings and status; change printer settings; download graphics, fonts, and firmware; create printer bitmap fonts; and to send additional commands to the printer. Using this convenient tool, you can explore the printer status and settings and troubleshoot the printer.
Note: This utility works with printer firmware V6.00 and later versions.

Start the Diagnostic Tool:

- (1) Double click on the Diagnostic tool icon  to start the software.
- (2) There are four features (Printer Configuration, File Manager, Bitmap Font Manager, Command Tool) included in the Diagnostic utility.

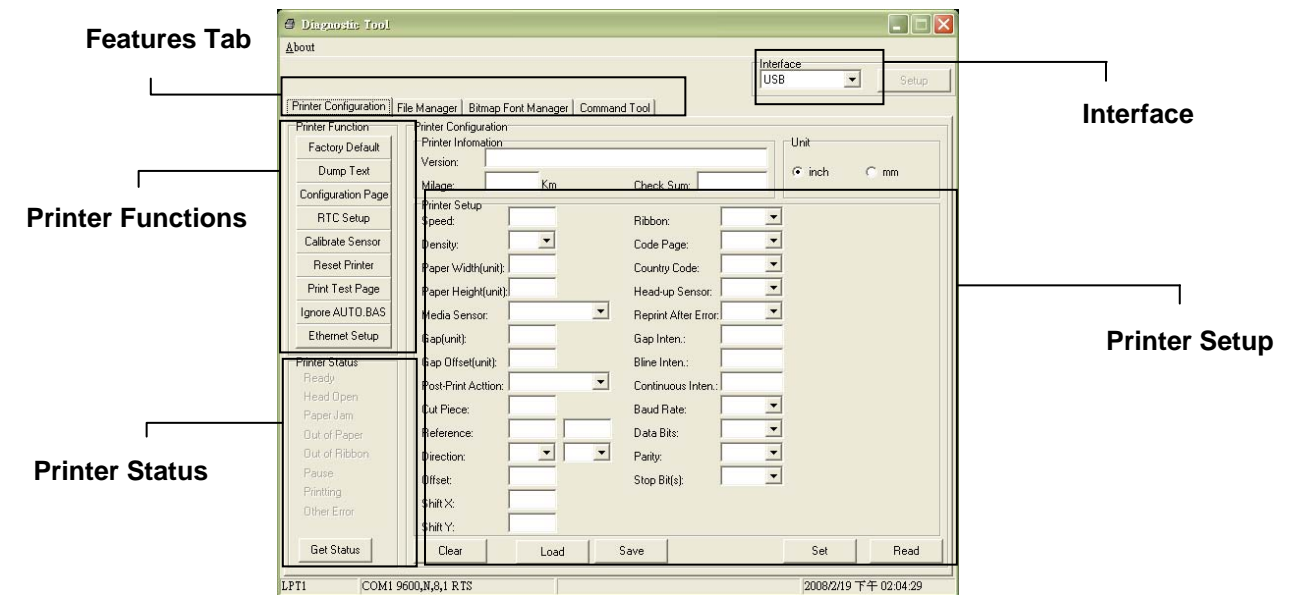

- (3) The detail functions in the Printer Function Group are listed as below.

Printer Function	Function	Description
Factory Default	Factory Default	Initialize the printer and restore the settings to factory default.
Dump Text	Dump Text	To activate the printer dump mode.
Configuration Page	Configuration Page	Print printer configuration.
RTC Setup	RTC Setup	Synchronize printer Real Time Clock with PC.
Calibrate Sensor	Calibrate Sensor	Calibrate the sensor specified in the Printer Setup group media sensor field.
Reset Printer	Reset Printer	Reboot the printer.
Print Test Page	Print Test Page	Print a test page.
Ignore AUTO.BAS	Ignore AUTO.BAS	Ignore the downloaded AUTO.BAS program.
Ethernet Setup	Ethernet Setup	Setup the IP address, subnet mask, gateway for the on board Ethernet.

* For more information and features about this printer, please refer to the User's Manual inside the CD disk.